

**NEW:**  
The Chubb safes Europa provides the highest level of protection for cash and valuables to international standards



# Europa (Grades 3 & 5)

burglary protection

### Key Features

- High quality cash safe protecting cash within an office environment with a high level of security of Grade 3 & 5
- The Europa range is tested to ECB.S and conforming to EN1143-1
- Passive and active relockers are incorporated into the boltwork to resist attack
- Chubb safes special barrier material is applied in the construction of the safe to protect against varying kinds of burglary attack

- Each safe can be equipped with high quality fittings to maximise storage requirements
- The Europa can be customised with a choice of locking options, deposits, shelves and lockable drawer deposits in order to meet customer requirements
- Base fixing is standard on all models



Tested to conform to  
AS/NZS 3809 (Safes and Strongrooms)  
Licenc No: SMK20290

**Chubb safes**  
Trusted the world over.

BURGLARY  
RESISTANCE

### Product Specifications

- All Chubb safes' locks are tested to VdS and conform to EN1143-1

The Europa 3 & 5 offer Key Lock with Keyless Combination locking as standard. A wide variety of electronic, time delay locks can be fitted on request.



Electronic Lock



Keylock

### Internal Fittings

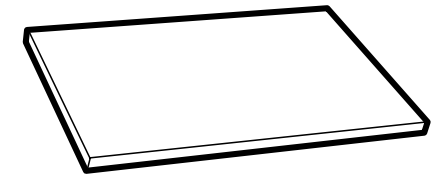
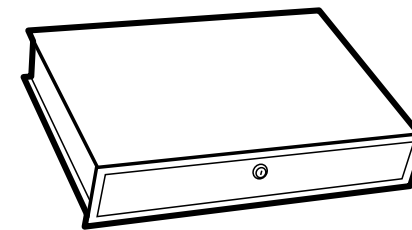
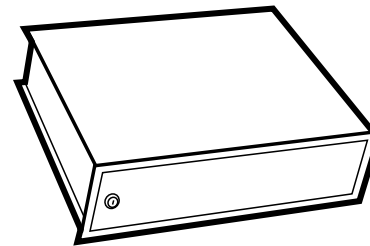

Authorised dealer:

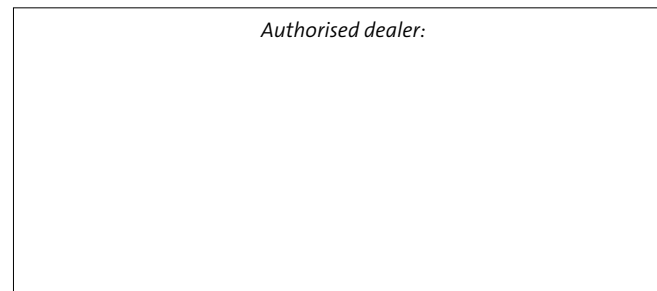

**Chubb safes**  
Trusted the world over.

Gunnebo Security Pty Ltd  
22 South Street, Rydalmere, NSW 2116  
Tel +61 2 8845 0700 Fax +61 2 8845 0731

Email: [info@chubbsafes.com.au](mailto:info@chubbsafes.com.au)

Website: [www.chubbsafes.com.au](http://www.chubbsafes.com.au)

'Chubb' is owned by Chubb plc and is a registered trademark used under license

## Locking Options

### Europa Dimensions

Grade	Size	External			Depth with door at 90° (F)	Width for full access (G)	Internal			Volume (L)	Net Weight (Kg)
		Height (A)	Width (B)	Depth (C)			Height	Width (D)	Depth (E)		
III	2	718	668	663	1277	1232	550	500	420	116	565
	3	1018	668	663	1277	1232	850	500	420	179	750
	4	1208	668	773	1387	1232	1040	500	530	276	1010
	5	1468	668	773	1387	1232	1300	500	530	345	1160
	6	1796	903	663	1510	1680	1628	735	420	503	1635
V	2	730	680	663	1277	1227	588	538	444	140	645
	3	1030	680	663	1277	1227	888	538	444	212	873
	4	1220	680	773	1387	1227	1078	538	554	322	1107
	5	1480	680	773	1387	1227	1338	538	554	400	1287
	6	1808	915	663	1510	1697	1666	773	444	572	1840
7	1808	915	773	1620	1697	1666	773	554	715	1968	

## Installation Guide

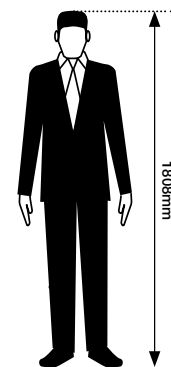
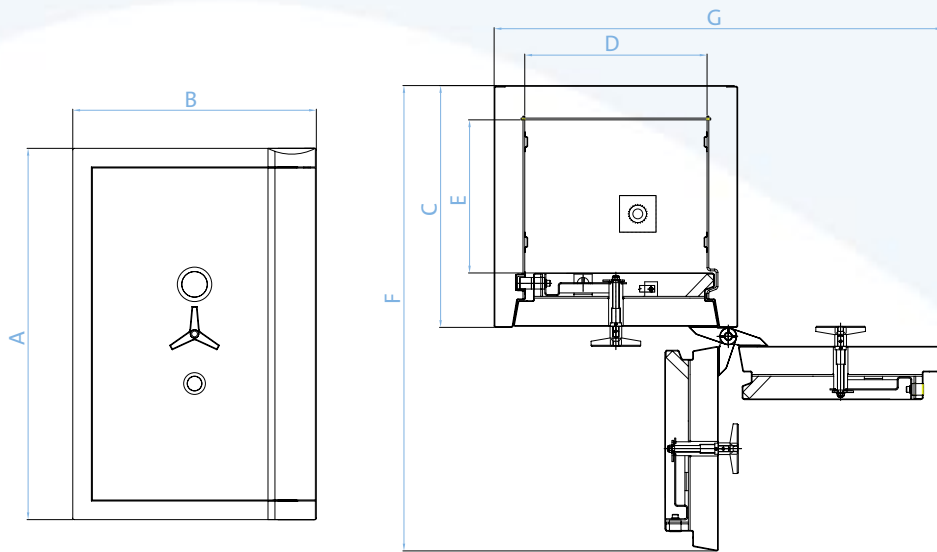

1808mm

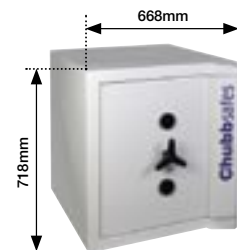

size 2

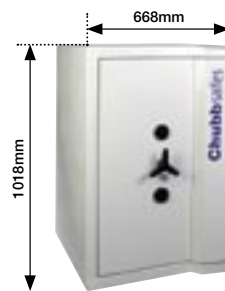

size 3

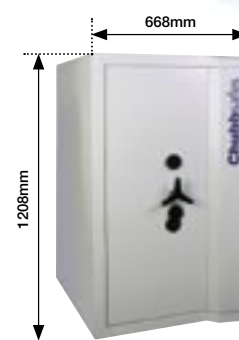

size 4

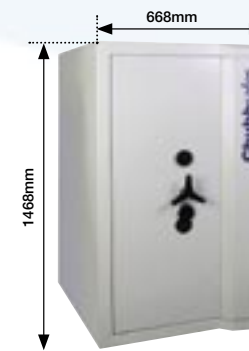

Size 5



size 6



size 7

NB: Fire protection is only available on sizes in Grade I-II

## Testing

A range of attack tools are used in the testing of Chubb safes Europa products from basic tools to the sophisticated tools like oxy-acetylene.



The Europa has been tested to the highest quality in its class against attack.



## Customising

Please ask for further assistance on how we can customise your storage requirements for secure, convenient use.

- Inner compartment as specified by customers



- Prepared to accept pneumatic system for depositing



- Envelope slot with anti-fish device



- Drawer deposit front or rear

